



Touch Think Intelligence Product Specification

Mainboard series

JWS3288-I

V1.4

www.touchthink.net

Shenzhen Touch Think Intelligence Co., Ltd.

CONTENTS

Chapter 1	
Introduction.....	- 3 -
1.1 Applicability.....	- 3 -
1.2 Functions.....	- 3 -
1.3 Features.....	- 3 -
Chapter 2 Basic Information.....	- 4 -
Chapter 3 PCB And Interface.....	- 5 -
3.1 PCB Drawing.....	- 6 -
3.2 Interface Parameter Definition.....	- 7 -
3.2.1 Power Input.....	- 8 -
3.2.2 RTC Battery.....	- 9 -
3.2.3 MIC.....	- 9 -
3.2.4 Telecontrol.....	- 10 -
3.2.5 Indicator.....	- 10 -
3.2.6 Backlight Control Port.....	- 11 -
3.2.7 LVDS.....	- 11 -
3.2.8 EDP Backlight Port.....	- 13 -
3.2.9 EDP.....	- 14 -
3.2.10 MIPI.....	- 15 -
3.2.11 232 *3.....	- 17 -
3.2.12 TTL *2.....	- 18 -
3.2.13 MIPI.....	- 18 -
3.2.14 IIC Switch Port.....	- 19 -
3.2.15 USB.....	- 20 -
3.2.16 Touch Screen(TP).....	- 21 -
3.2.17 Speaker.....	- 21 -
3.2.18 GPIO.....	- 22 -
3.2.19 Button.....	- 22 -
3.2.20 Other Standard Interfaces And Functions.....	- 23 -
Chapter 4 Electrical Parameter.....	- 24 -
Chapter 5 Assembling Cautions.....	- 25 -

Chapter 1 Introduction

1.1 Applicability

JWS3288-I is a intelligent terminal motherboard can be applied in advertising machine, digital signage, intelligent self-service terminal, intelligent vending machine, O2O smart equipment, industrial control computer, robot and other equipment.

1.2 Functions

JWS3288-I uses RK3288 Cortex-A17 quad-core processor, its basic frequency is 1.6GHz,it supports Android7.1/10.0 OS. JWS3288-I Uses Mali-T764 GPU, it has H.265 hardware decoder to supports 4K display. Whether it is game, test performance score or decoding, JWS3288-I is your best choice for human-computer interaction and industrial control projects.

1.3 Features

- High integration, JWS3288-I integrated LVDS/EDP/Ethernet/HDMI/WIFI/Blue tooth functions to itself.
- Built-in PCI-E 4G module. JWS3288-I Supports PCIE 3G/4G module from HUAWEI,ZTE or other brand, it also supports VoLTE.
- Various expansion interfaces. JWS3288-I has eight USB ports(six internal expansion ports and two USB standard ports.), a 232 port, two switchable TTL/232 ports, it can suit your customization requirement.
- High definition.JWS3288-I supports 4K 3840x2160 decoding and LCD display with various LVDS/EDP ports, it also supports Special-shaped screens of various sizes and resolutions.
- Android system customization. JWS3288-I provides system calling interface and API reference code, it supports upper-layer application' s development perfectly.
- JWS3288-I supports infrared, optical, capacitance, resistance and other mainstream touch screen, it also supports drive-free HID configuration which no need to debug before using.
- WIFI module supports 2.4G/5G frequency and 5.0 blue-tooth.

Chapter 2 Basic Informatio

Specifications	
CPU	RK3288, Quad-core, 1.6GHz
Memory	2G(4G optional)
Storage	EMMC 16G(8/32/64G optional,maximum 64G)
ROM	4KB EEPROM
Resolution	Maximum 3840*2160
OS	Android 7.1/10.0/12.0 Linux4.4/Ubuntu18.04/Debian10.0
Play Mode	Supports multiple play modes such as loop,timing and interstitial.
Network	4G,Ethernet,WiFi/BT5.0,Wireless peripheral extension
Video Format	Support WMV,AVI,FLV,RM,RMVB,MPEG,TS,MP4 etc
Photograph	Support BMP,JPEG,PNG,GIF
USB	USB HOST*1,USB OTG*1,USB interface*6
Serial Port	232*1, TTL/232 switch port*2
GPS	External GPS(Optional)
WIFI、 BT	Built-in dual frequency WIFI, BT5.0
3G	Unlocked,Support voice call(base on 4G module,Optional)
Ethernet	10M/100M/1000M adapt Ethernet
TF Card	Trans flash Card supported
LVDS	LVDS*1,support 50/60Hz LCD panel
EDP	Support Multi-resolution EDP interface LCD panel
HDMI	HDMI*1, support 1080P@120Hz, 4kx2k@60Hz output
HDMI IN	Video signal input only
AV Output	Support left and right channel output, built-in dual 4Ω/20W, 8Ω/10W amplifier
Real Time Clock	Supported
Timing turn	Supported
OS upgrade	Support upgrade through TF,USB

Chapter 3 PCB And Interface

【Front】

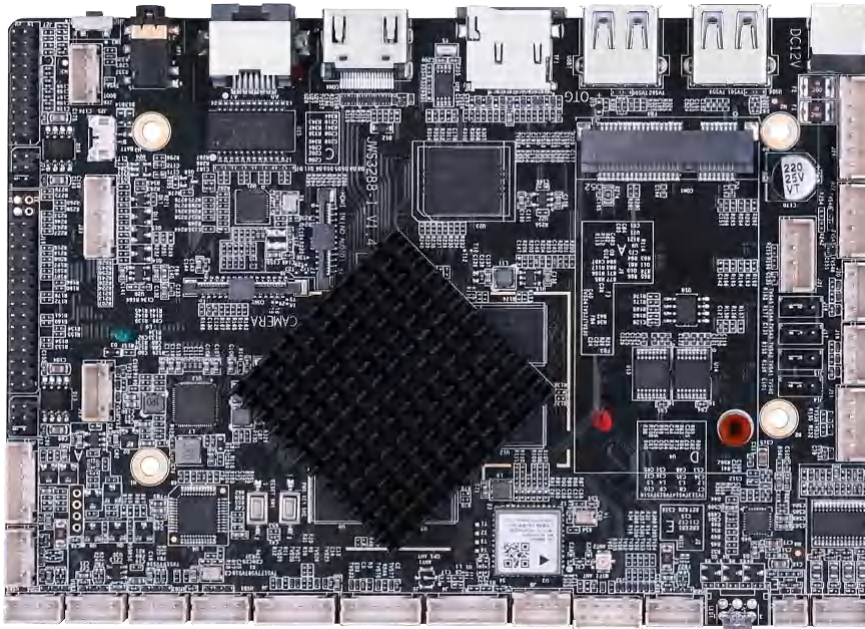

【Back】

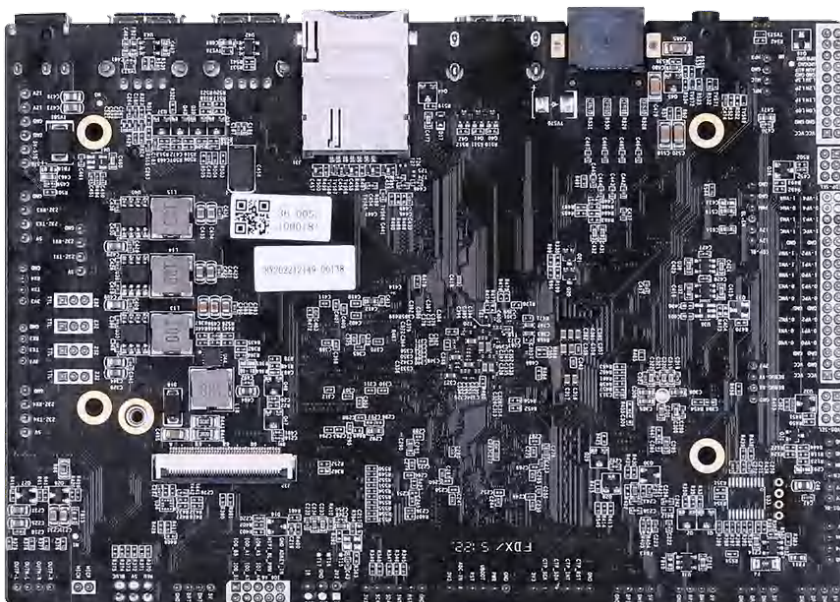

【Seaboard Interface】



3.1 PCB Drawing

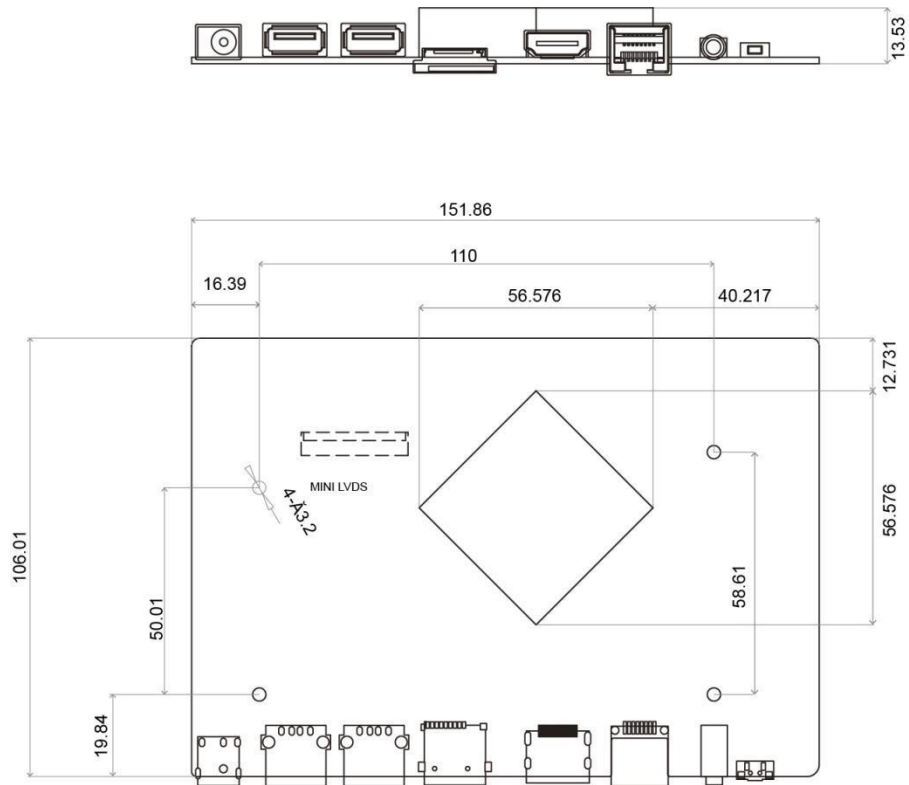

3.2 Interface Parameter Definition

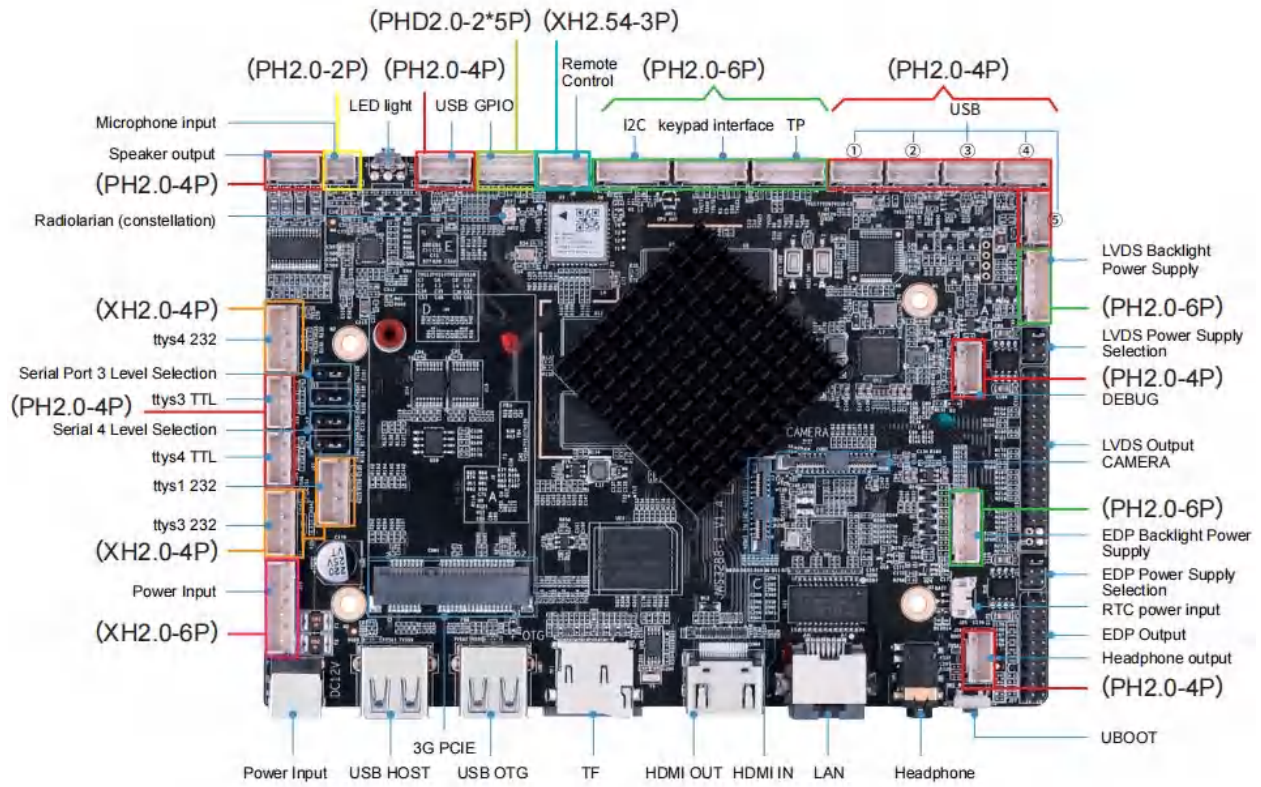

◆ 3.2.1 Power Input

Apply 12V DC power supply, motherboard can only uses power input from DC port or power input port, the adaptor DC input connector size is D5.5, d2.0.

When motherboard is under idling state, the minimum current 12V DC power supported is 600mA.

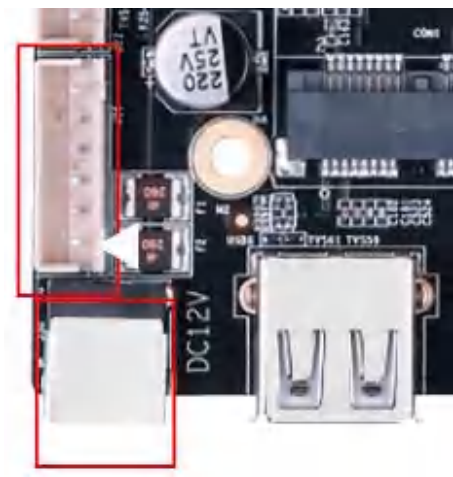

SN	DEFN	Property	Description
1	VCC	INPUT	12V Input
2	VCC	INPUT	12V Input
3	GND	GROUND	Ground
4	GND	GROUND	Ground
5	5V-	INPUT	5V Input
6	STB	I/O	Connect to MCU pin

5V-STB and STB(I/O) are designed for power board standby function, if customer need low-power consumption standby, connect 5V-STB(JWS3288-I) to 5V-STB(Power board) and connect STB(Output) to PS_ON(Power board), please notice that different brand of power board might have difference on definition of those two pins, please refer to actual conditions.

If this function is not needed, user can disconnect those two pins(in this situation motherboard will disable standby function).

◆ 3.2.2 RTC Battery

Supply power to OS clock when peripheral power disconnect.



SN	DEEN	Property	Description
1	RTC	INPUT	3V Input
2	GND	GROUND	Ground

◆ 3.2.3 MIC

Please mind MIC P/N poles.

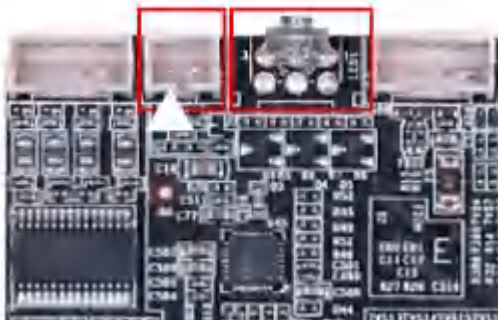

SN	DEEN	Property	Description
1	MIC1N	INPUT	MIC-
2	MIC1P	INPUT	MIC+

◆ 3.2.4 Telecontrol

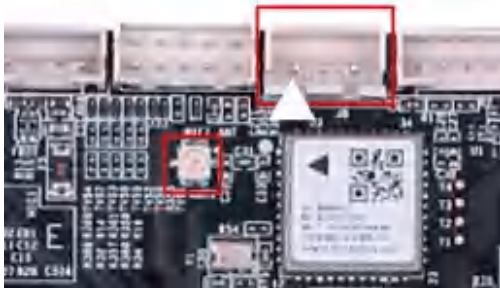

SN	DEFN	Property	Description
1	IR	INPUT	Telecontrol signal Input
2	GND	GROUND	Ground
3	3V3	Power	3.3V Output

◆ 3.2.5 Indicator

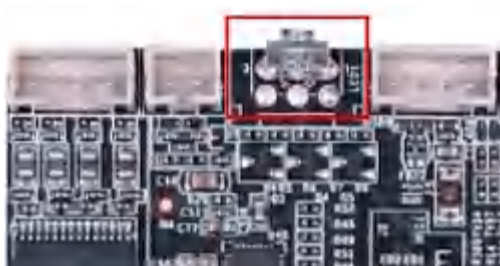

SN	DEFN	Property	Description
1	LED_B	Blue	Work state indicator
2	VCC	Power	3.3V Output
3	LED_R	Red	Standby state indicator

◆ 3.2.6 Backlight Control Port

This port is designed for LVDS/EDP panel's backlight control function, the current of 12V power supply is 2A, if screen backlight power beyond 24W, in order to prevent system unstable, please connect backlight cable to another power panel. This port can only be used to supply backlight power, never connect it to other device as power input.

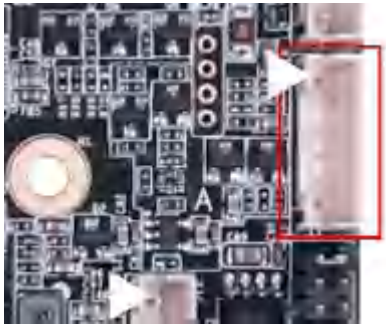

SN	DEFN	Property	Description
1	GND	GROUND	Ground
2	GND	GROUND	Ground
3	BL_ADJ	OUTPUT	Backlight brightness control
4	BL_EN	OUTPUT	Backlight dis/enable control
5	VCC	Power	12V Output
6	VCC	Power	12V Output

◆ 3.2.7 LVDS

Common LVDS pin definition, support single/dual, 6/8bit LVDS panel, user can change port voltage level by move jumper cap position, 3.3V/5V/12V optional.

To prevent board and screen panel burning-out, please notice below:

1. Confirm LVDS screen panel's voltage in SPEC is correct and it's correspond to motherboard power supply, please also confirm that motherboard can provide maximum current which LVDS screen panel required.
2. Please use multimeter to test motherboard output voltage, make sure jumper cap mounted on the right position.
3. When you connect a 6/8bit LVDS screen, make sure pin on cable and motherboard is aligned (pin1 to pin1 for example).

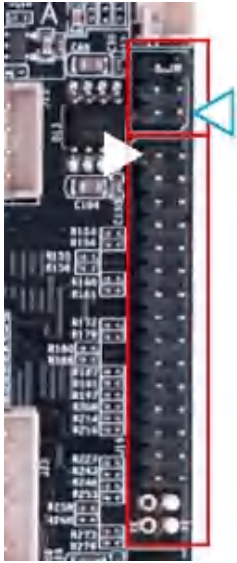

SN	DEFN	Property	Description
1	VCC	Power OUTPUT	LCD power Output, +3.3v/+5V/+12V(Optional)
2			
3			
4	GND	GROUND	Ground
5			
6			
7	D0N	OUTPUT	Pixel0 Negative Data (Odd)
8	D0P	OUTPUT	Pixel0 Positive Data (Odd)
9	D1N	OUTPUT	Pixel1 Negative Data (Odd)
10	D1P	OUTPUT	Pixel1 Positive Data (Odd)
11	D2N	OUTPUT	Pixel2 Negative Data (Odd)
12	D2P	OUTPUT	Pixel2 Positive Data (Odd)
13	GND	GROUND	Ground
14	GND	GROUND	Ground
15	CL0N	OUTPUT	Negative Sampling Clock (Odd)
16	CL0P	OUTPUT	Positive Sampling Clock (Odd)
17	D3N	OUTPUT	Pixel3 Negative Data (Odd)
18	D3P	OUTPUT	Pixel3 Positive Data (Odd)
19	D5N	OUTPUT	Pixel0 Negative Data (Even)
20	D5P	OUTPUT	Pixel0 Positive Data (Even)
21	D6N	OUTPUT	Pixel1 Negative Data (Even)

22	D6P	OUTPUT	Pixel1 Positive Data (Even)
23	D7N	OUTPUT	Pixel2 Negative Data (Even)
24	D7P	OUTPUT	Pixel2 Positive Data (Even)
25	GND	GROUND	Ground
26	GND	GROUND	Ground
27	CL1N	OUTPUT	Negative Sampling Clock (Even)
28	CL1P	OUTPUT	Positive Sampling Clock (Even)
29	D8N	OUTPUT	Pixel3 Negative Data (Even)
30	D8P	OUTPUT	Pixel3 Positive Data (Even)

◆ 3.2.8 EDP Backlight Port

This port is designed for EDP panel's backlight control function, the current of 12V power supply is 2A, if screen backlight power beyond 24W, in order to prevent system unstable defect, please connect backlight cable to other power panel. Backlight dis/enable control voltage is 5V, if EDP screen request other voltage, please add IO level-shift circuit. This interface can only be used to supply backlight power, never connect it to other device as power input.

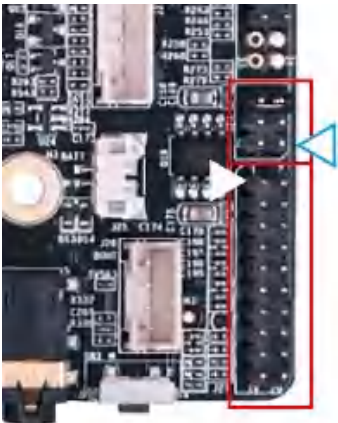

SN	DEFN	Property	Description
6	VCC	Power	12V Output
5	VCC	Power	12V Output
4	EN	OUTPUT	Backlight dis/enable control
3	PWM	OUTPUT	Backlight brightness control
2	GND	GROUND	Ground
1	GND	GROUND	Ground

◆ 3.2.9 EDP

Jumper cap can be mounted on different position(see below picture left side) to change power output(3.3V/5V/12V), please take a look at silkscreen on PCB backside.

Please check the pin definition on board and cable, make sure pin on cable and board is aligned(pin1 to pin1 for example).

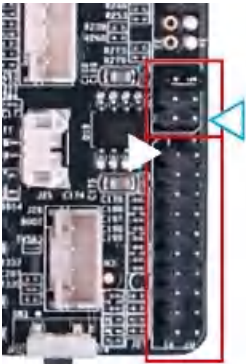

SN	DEFN	Property	Description
1	VCC	Power OUTPUT	LCD Power Output, +3.3V/+5V/+12V optional
2			
3	GND	GROUND	Ground
4			
5	TX0P	OUTPUT	EDP Pixel0 Positive Data (Odd)
6	TX0N	OUTPUT	EDP Pixel0 Negative Data (Odd)
7	TX1P	OUTPUT	EDP Pixel1 Positive Data (Odd)
8	TX1N	OUTPUT	EDP Pixel1 Negative Data (Odd)
9	TX2P	OUTPUT	EDP Pixel2 Positive Data (Odd)
10	TX2N	OUTPUT	EDP Pixel2 Negative Data (Odd)
11	TX3P	OUTPUT	EDP Pixel3 Positive Data (Odd)
12	TX3N	OUTPUT	EDP Pixel3 Negative Data (Odd)
13	GND	GROUND	Ground
14	GND	GROUND	Ground
15	AUXP	OUTPUT	EDP AUX Positive Data (Odd)
16	AUXN	OUTPUT	EDP AUX Negative Data (Odd)
17	GND	GROUND	Ground
18			
19			
20	HPD	INPUT	EDP Detect

◆ 3.2.10 MIPI

MIPI port supports single channel MIPI LCD screen, for 4 channels MIPI port, the maximum resolution and frequency port can support is 1920*1200@60fps.

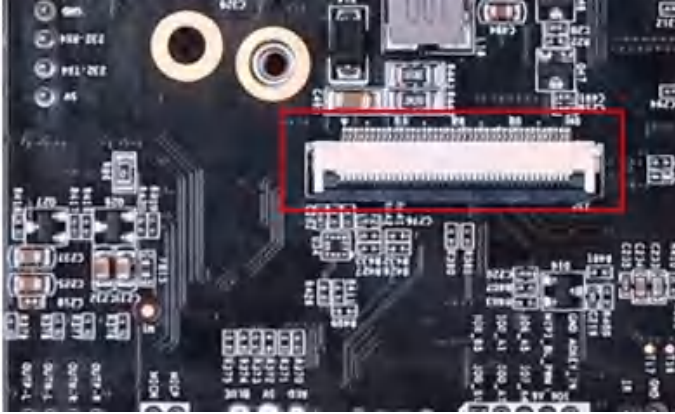

SN	DEFN	Property	Description
1	NC	-	Not connect
2	VDD	Power	Digital power
3	VDD	Power	Digital power
4	GND	GROUND	Ground
5	REST	OUTPUT	Global reset pin
6	NC	-	Not connect
7	GND	GROUND	Ground
8	D0N	OUTPUT	Negative MIPI differential data output
9	D0P	OUTPUT	Positive MIPI differential data output
10	GND	GROUND	Ground
11	D1N	OUTPUT	Negative MIPI differential data output
12	D1P	OUTPUT	Positive MIPI differential data output
13	GND	GROUND	Ground
14	CLKN	OUTPUT	Negative MIPI differential data output
15	CLKP	OUTPUT	Positive MIPI differential data output
16	GND	GROUND	Ground

17	D2N	OUTPUT	Negative MIPI differential data output
18	D2P	OUTPUT	Positive MIPI differential data output
19	GND	GROUND	Ground
20	D3N	OUTPUT	Negative MIPI differential data output
21	D3P	OUTPUT	Positive MIPI differential data output
22	GND	GROUND	Ground
23	NC	-	Not connect
24	NC	-	Not connect
25	GND	GROUND	Ground
26	NC	-	Not connect
27	NC	-	Not connect
28	NC	-	Not connect
29	NC	-	Not connect
30	GND	GROUND	Ground
31	LED-	Power	LED Cathode
32	LED-	Power	LED Cathode
33	NC	-	Not connect
34	NC	-	Not connect
35	NC	-	Not connect
36	NC	-	Not connect
37	NC	-	Not connect
38	NC	-	Not connect
39	LED+	Power	LED Anode
40	LED+	Power	LED Anode

◆ 3.2.11 232 *3

Motherboard provides three 232 serial ports which can support mainstream 232 serial port devices.

Note:

1.232 serial port level on motherboard must correspond to device' s level, those serial ports don' t support TTL/485 device direct connection.

2.TX/RX pin should connected to cable TX/RX pin correctly.

3.Jumper cap can be mounted on different position to chose level, relationship between jumper cap and serial port is: cap J14 for TTL port J15;cap J16 for 232port J22;cap J17 for TTL port J20;cap J14 for 232 port J15.

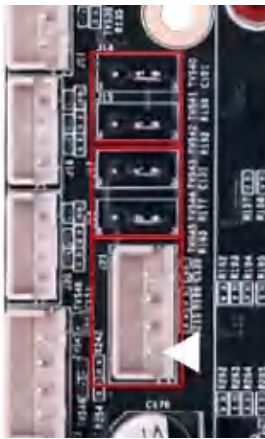

SN	DEFN	Property	Description
1	GND	GROUND	Ground
2	232-RX	INPUT	232-RX
3	232-TX	OUTPUT	232-TX
4	VCC	Power	5V Output

◆ 3.2.12 TTL *2

Board provides 2 TTL serial ports which can support mainstream serial ports devices. The voltage for TTL serial ports is 0V~3.3V, if device connected request higher voltage, there must be an isolate circuit or level-shift circuit, otherwise board and device might get burnout.

Note:

TTL serial port level must matched with device's level, those port don't support MAX232/485 device direct connect.

TX/RX pin connected to cable TX/RX pin correctly (positive and negative for example) .

Jumper cap can be mounted on different position to chose level for those port, relationship between cap and port is: cap J14 for TTL port J15;cap J16 for 232port J22;cap J17 for TTL port J20;cap J14 for 232 port J15.

◆ 3.2.13 MIPI

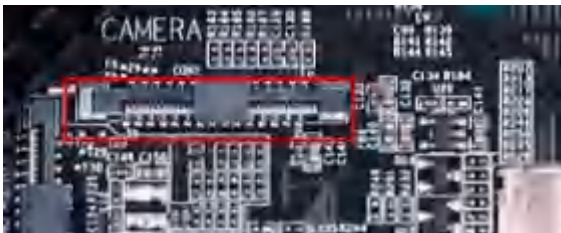

Motherboard supports MIPI cameras with maximum 1300W pixels, the electrical definition as below:

SN	DEFN	Property	Description
1	NC	/	/
2	VDD	Power	2.8V Output
3	DVDD	Power	1.2V Output
4	DOVDD	Power	1.8V Output
5	NC	/	/
6	GND	GROUND	Ground
7	VDD	Power	2.8V Output
8	GND	GROUND	Ground
9	I2C3_SD	INPUT/OUT	SDA Signal
10	I2C3_SC	OUTPUT	SCL Signal

11	RST	OUTPUT	Reset Signal
12	PWDN	OUTPUT	Power Down
13	GND	GROUND	Ground
14	MCLK	OUTPUT	Main Clock
15	GND	GROUND	Ground
16	D3P	INPUT/OUT	MIPI Data Channel 3 Positive
17	D3N	INPUT/OUT	MIPI Data Channel 3 Negative
18	GND	GROUND	Ground
19	D2P	INPUT/OUT	MIPI Data Channel 2 Positive
20	D2N	INPUT/OUT	MIPI Data Channel 2 Negative
21	GND	GROUND	Ground
22	D1P	INPUT/OUT	MIPI Data Channel 1 Positive
23	D1N	INPUT/OUT	MIPI Data Channel 1 Negative
24	GND	GROUND	Ground
25	CLKP	INPUT/OUT	MIPI Clock Channel Positive
26	CLKN	INPUT/OUT	MIPI Clock Channel Negative
27	GND	GROUND	Ground
28	D0P	INPUT/OUT	MIPI Data Channel 0 Positive
29	D0N	INPUT/OUT	MIPI Data Channel 0 Negative
30	GND	GROUND	Ground

◆ 3.2.14 IIC Switch Port

With a transform board from our company, I2C switch port can transform to TTL serial port or 8 channel GPIO port. This port is designed for situations that lack of TTL/GPIO interface.



SN	DEFN	Property	Description
1	VCC	Power	3.3V Output
2	SCK	INPUT/OUTPUT	I2C Clock
3	SDA	INPUT/OUTPUT	I2C Data
4	INT	INPUT/OUTPUT	Interrupt
5	RST	INPUT/OUTPUT	Reset
6	GND	GROUND	Ground

◆ 3.2.15 USB

Motherboard provides two Host USB standard ports(host*1,OTG*1) and six internal USB ports.

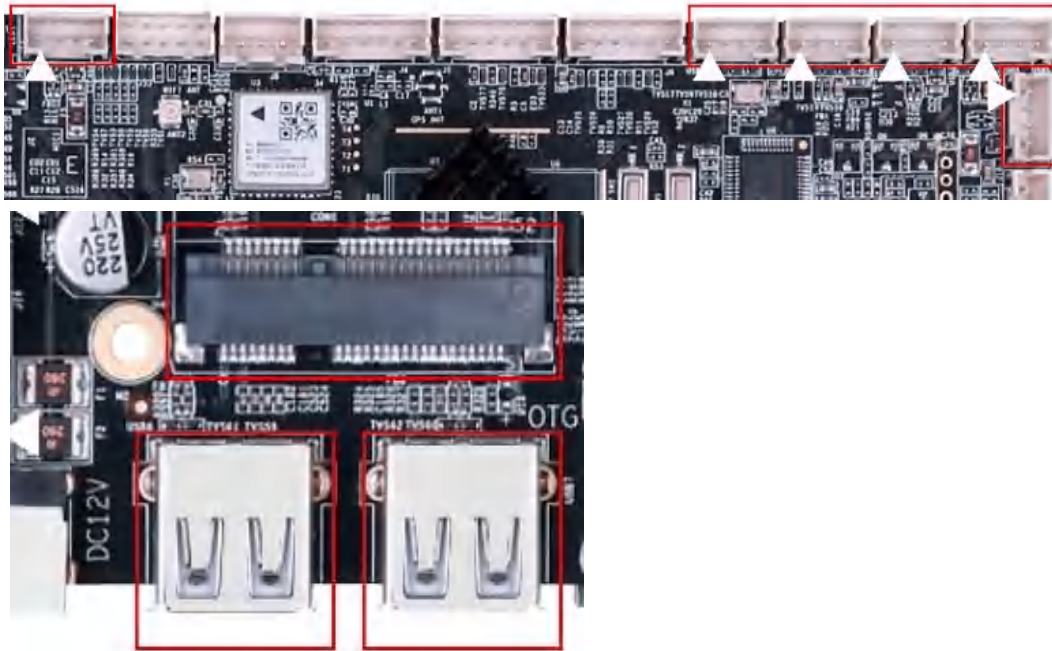

SN	DEFN	Property	Description
1	VCC	Power	5V Output
2	DM	INPUT/OUT	DM
3	DP	INPUT/OUT	DP
4	GND	GROUND	Ground

◆ 3.2.16 Touch Screen(TP)



SN	DEFN	Property	Description
1	VCC	Power	3.3V Output
2	RST	INPUT/OUTP	Reset
3	INT	INPUT/OUTP	Interrupt
4	SCL	INPUT/OUTP	I2C Clock
5	SDA	INPUT/OUTP	I2C Data
6	GND	GROUND	Ground

◆ 3.2.17 Speaker

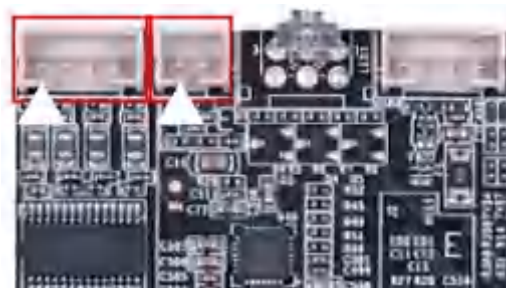

SN	DEFN	Property	Description
1	RP	OUTPUT	Audio Output Right+
2	RN	OUTPUT	Audio Output Right-
3	LN	OUTPUT	Audio Output Left-
4	LP	OUTPUT	Audio Output Left+

◆ 3.2.18 GPIO

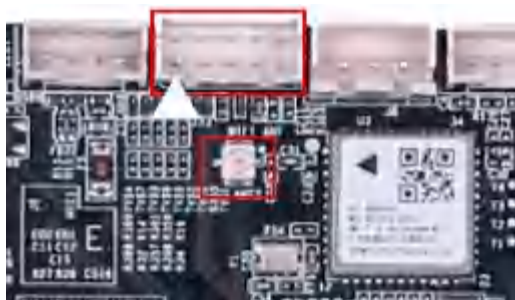

SN	DEFN	Property	Description
	GPIO0_B5	INPUT/OUTPUT	IO Port
2	GPIO0_B1	INPUT/OUTPUT	IO Port
3	GPIO0_A1	INPUT/OUTPUT	IO Port
4	GPIO0_A7	INPUT/OUTPUT	IO Port
5	GPIO6_A5	INPUT/OUTPUT	IO Port
6	GPIO7_A4	INPUT/OUTPUT	IO Port
7	MIPI_BL_P	NC	NC
8	GPIO6_A6	INPUT/OUTPUT	IO Port
9	GND	GROUND	Ground
10	ADC_IN	INPUT	ADC Signal

◆ 3.2.19 Button

SN	DEFN	Property	Description
1	VCC	Power	5V Output
2	ADC	INPUT	ADC Signal
3	RST	INPUT	Reset Signal
4	UBOOT	INPUT	Connect To A Upgrade Button
5	PWR_ON	INPUT	Connect To A Power Button
6	GND	GROUND	Ground

◆ 3.2.20 Other Standard Interfaces And Functions

Storage	TF card	Data storage, maximum 1T
	USB	HOST interface, support data storage/input, USB mouse/key board, camera, touch screen etc.
Ethernet	RJ45	Support 1000M wired internet
HDMI	Standard	Support HDMI data output, maximum definition 1080P
Audio	Standard	3.55mm standard interface
3G	PCI-E Standard	Support HUAWEI,ZTE or other brand's PCI-E 3G/4G module
SIM	Standard	Support all standard(depend on 3G module)

Chapter 4 Electrical Parameter

ITEM		MIN	NORMAL	MAX
Power	Voltage	--	12V	--
	Ripple	--	--	50mV
	Current	3A		
Working parameter(HDMI screen only)	Work	--	200mA	350mA
	Standby	--	17mA	20mA
	USB Supply	--	--	500mA
LVDS	3.3V	--	400 mA	500 mA
	5V	--	550 mA	1A
	12V	--	580 mA	1A
	USB Supply	--	--	500mA
EDP	3.3V		400 mA	500 mA
	5V	--	--	--
	12V	--	--	--
	USB Supply	--	--	500mA
Total output	Current	3.3V	--	800mA
Environment	Relative humidity	--	--	80%
	Operating temperature	0°C	--	60°C
	Storage temperature	-20°C	--	70°C

Remark 1:

Please choose the right backlight working voltage(3.3V,5V) for LVDS screen. To prevent device burnout, please confirm LVDS screen's maximum working current before connect it to our motherboard.

Remark 2:

When connect motherboard to EDP/LVDS screen, motherboard's working voltage and current is depend on EDP/LVDS screen, therefore we didn't list those parameter on above list.

Chapter 5 Assembling Cautions

During assembling, please pay attention to notes below.

1. No short circuit between board and device;
2. Avoid motherboard bend or twist when mounted on user's device frame;
3. Confirm LVDS/EDP screen's requested voltage and current is correspond to motherboard output, mind the connector's pin definition and connect the pin correctly;
4. If backlight power requested is beyond 20W, please connect backlight to another power board;
5. When user mounting peripheral device(USB,IO etc), please mind the IO level and current output ;
6. When mounting serial port,pleas mind whether 232/485 device is connected and TX/RX pin connected correctly;
7. Check whether power input connected to input interface, make sure total input voltage and total input current suit user's request, please don't use backlight interface to supply power to other device.